

MARÇAL

HOME DECOR PRODUCTS

ACCESORIOS DE BAÑO



HOME DECOR PRODUCTS

MATERIAL SANITARIO

ACCESORIOS SANITARIOS PAG. 29-34
ESPEJOS PAG. 35-36

TOALLEROS

SERIE-LINE PAG. 7-8
SERIEDIAGONAL PAG. 9-10
SERIEETERNITY PAG. 11-12
SERIEFLUX PAG. 13-16
SERIEFLOW PAG. 17-20
SERIEOPORTO PAG. 21-22
SERIEOVAL PAG. 23-25

HOTELES ZONAS PÚBLICAS

SERIEYES PAG. 39-40



MARÇAL

HOME DECOR PRODUCTS





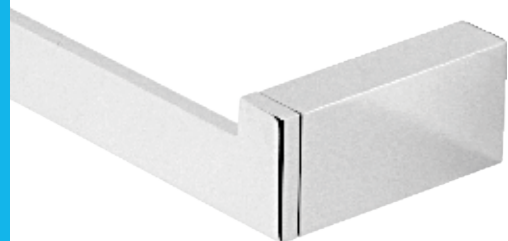

TOALLEROS



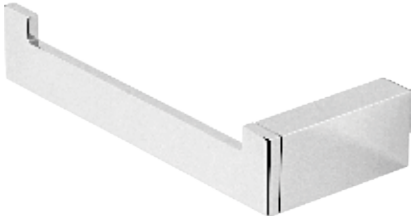

MARÇAL
HOME DECOR PRODUCTS

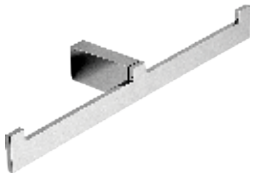

ARTÍCULO	DESCRIPCIÓN	REFERENCIA	PRECIO
	TOALLERO FIJO C/30cm	9001010030	68,57 €
	TOALLERO FIJO C/50cm	9001010050	97,71 €
	TOALLERO FIJO C/60cm	9001010060	112,86 €
	TOALLERO BIDÉ	9043010000	70,00 €
	PORTARROLOS	9041010000	40,00 €
	PORTARROLOS DOBLE	9042010000	67,14 €
	COLGADOR	9011010001	16,43 €

TOALLEROS -TOALLEROS -TOALLEROS -TOALLEROS -TOALLEROS -TOALLEROS -TOALLEROS -TOALLEROS -TOALLEROS -TOALLEROS -TOALLEROS -TOALLEROS -TOALLEROS -TOALLEROS -TOALLEROS -TOALLEROS

ARTÍCULO	DESCRIPCIÓN	REFERENCIA	PRECIO
	TOALLERO FIJO C/30cm	9001015030	68,57 €
	TOALLERO FIJO C/50cm	9001015050	91,43 €
	TOALLERO FIJO C/60cm	9001015060	105,71 €

	PORTARROLOS	9009015000	31,43 €
---	-------------	------------	---------





	PORTARROLOS DOBLE	9042015000	48,57 €
---	-------------------	------------	---------





	PORTARROLOS CON TOALLERO BIDÉ	9054015000	57,14 €
--	-------------------------------	------------	---------

ARTÍCULO	DESCRIPCIÓN	REFERENCIA	PRECIO
	COLGADOR	9011015001	17,57 €





	COLGADOR DOBLE	9011015002	28,57 €
---	----------------	------------	---------





	PORTAESCOBILLA CUADRADO SUELO	9016002001	104,00 €
	PORTAESCOBILLA CUADRADO PARED	9016002002	108,29 €





ARTÍCULO	DESCRIPCIÓN	REFERENCIA	PRECIO
	COLGADOR	9011011001	17,57 €
	COLGADOR DOBLE	9011011002	22,29 €
	TOALLERO FIJO C/40cm	9007011040	184,14 €
	TOALLERO FIJO C/60cm	9007011060	206,43 €
	PORTAESCOBILLA CUADRADO SUELO	9016002001	104,00 €
	PORTAESCOBILLA CUADRADO PARED	9016002002	108,29 €





ARTÍCULO	DESCRIPCIÓN	REFERENCIA	PRECIO
	TOALLERO FIJO C/30cm	9001002030	39,71 €
	TOALLERO FIJO C/50cm	9001002050	42,86 €
	TOALLERO FIJO C/60cm	9001002060	44,57 €
	TOALLERO FIJO DOBLE C/50cm	9002002050	60,43 €
	TOALLERO FIJO DOBLE C/60cm	9002002060	63,57 €
	TOALLERO ROTATIVO C/50cm	9003002050	76,29 €
	TOALLERO ANILLA CUADRADO	9005002000	39,71 €
	PORTARROLOS CON TAPA	9009002000	41,29 €





ARTÍCULO	DESCRIPCIÓN	REFERENCIA	PRECIO
	PORTARROLOS	9008002000	30,29 €
	PORTARROLOS DE REPUESTO	9010002000	31,86 €
	PORTAVASOS CON VASO	9013002000	39,71 €
	PORTASECADOR	9014002000	47,71 €

ARTÍCULO	DESCRIPCIÓN	REFERENCIA	PRECIO
	JABONERA PARED MEDIANA	9018002000	103,29 €
	ESTANTE CRISTAL C/50cm	9012002050	79,43 €
	TOALLERO FIJO C/40cm	9007002040	146,14 €
	TOALLERO FIJO C/60cm	9007002060	158,86 €
	PORTAESCOBILLA CUADRADO SUELO	9016002001	104,00 €
	PORTAESCOBILLA CUADRADO PARED	9016002002	108,29 €





ARTÍCULO	DESCRIPCIÓN	REFERENCIA	PRECIO
	TOALLERO FIJO C/30cm	9001001030	39,71 €
	TOALLERO FIJO C/50cm	9001001050	42,86 €
	TOALLERO FIJO C/60cm	9001001060	44,57 €
	TOALLERO FIJO DOBLE C/50cm	9002001050	60,43 €
	TOALLERO FIJO DOBLE C/60cm	9002001060	63,57 €
	TOALLERO ROTATIVO C/50cm	9003001050	76,29 €
	TOALLERO ANILLA REDONDO	9005001000	30,29 €
	PORTARROLOS CON TAPA	9009001000	41,29 €

ARTÍCULO	DESCRIPCIÓN	REFERENCIA	PRECIO
	PORTARROLOS	9008001000	30,29 €
	PORTARROLOS DE REPUESTO	9010001000	31,86 €
	PORTAVASOS CON VASO	9013001000	39,71 €
	PORTASECADOR	9014001000	47,71€

ARTÍCULO	DESCRIPCIÓN	REFERENCIA	PRECIO
	COLGADOR	9011001001	16,00 €
	COLGADOR DOBLE	9011001002	20,71 €
	COLGADOR TRIPLE	9011001003	54,00 €
	JABONERA PARED CRISTAL	9021001000	39,71 €
	JABONERA PARED PEQUEÑA	9017001000	52,43 €





ARTÍCULO	DESCRIPCIÓN	REFERENCIA	PRECIO
	TOALLERO FIJO C/ 30cm	9001005030	60,00 €
	TOALLERO FIJO C/ 50cm	9001005050	68,57 €
	TOALLERO FIJO C/ 60cm	9001005060	74,29 €
	TOALLERO ANILLA REDONDO	9005005000	54,29 €
	PORTARROLOS CON TAPA	9009005000	57,14 €
	PORTARROLOS	9008005000	34,29 €
	PORTAVASOS CON VASO	9013005000	42,86 €

ARTÍCULO	DESCRIPCIÓN	REFERENCIA	PRECIO
	PORTAESCOBILLA CRISTAL	9015005002	68,57 €
	JABONERA PARED CRISTAL	9021005000	48,57 €
	JABONERA PARED PEQUEÑA	9017005000	47,14 €
	JABONERA PARED GRANDE	9019005000	65,71 €
	COLGADOR DOBLE	9011005002	28,57 €

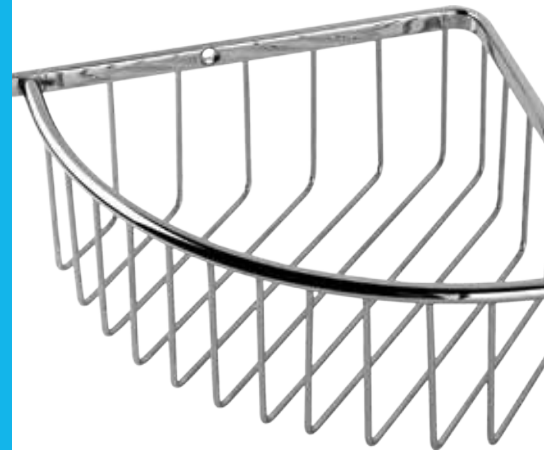
ARTÍCULO	DESCRIPCIÓN	REFERENCIA	PRECIO
	PORTARROLOS	9008003000	38,14 €
	PORTARROLOS DE REPUESTO	9010003000	36,57 €
	PORTAVASOS CON VASO	9013003000	40,00 €
	PORTAESCOBILLA CRISTAL	9015003000	64,29 €

MATERIAL SANITARIO - ESPEJOS



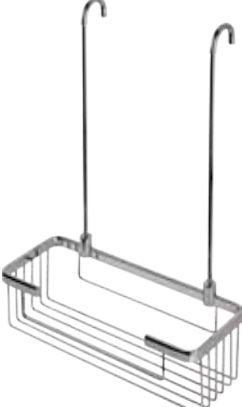



ARTÍCULO	DESCRIPCIÓN	REFERENCIA	PRECIO
	DISPENSADOR JABÓN	9062014001	78,57 €
	DISPENSADOR JABÓN PARED	9062014002	82,86 €
	JABONERA ESQUINA ALTA	9023010000	57,14 €
	JABONERA ESQUINA BAJA	9024010000	52,86 €
	JABONERA ESQUINA DOBLE	9025010000	117,14 €
	JABONERA RECTANGULAR MEDIANA ALTA COLGANTE	9026010000	108,57 €

ARTÍCULO	DESCRIPCIÓN	REFERENCIA	PRECIO
	JABONERA RECTANGULAR DOBLE COLGANTE	9026020000	211,43 €
	JABONERA RECTANGULAR MEDIANA ALTA	9029010000	74,29 €
	JABONERA RECTANGULAR MEDIANA PEQUEÑA	9029020000	71,43 €
	BARRA DE APOYO BAÑERA C/40cm	9058010400	85,71 €
	BARRA DE APOYO BAÑERA C/50cm	9058010500	90,71 €
	BARRA DE APOYO BAÑERA C/60cm	9058010600	95,71 €
	BARRA DE APOYO BAÑERA 3 SOPORTES C/80cm	9058010800	127,14 €
	CUBO ACERO INOX 3 LTS	9048010000	19,29 €

ARTÍCULO	DESCRIPCIÓN	REFERENCIA	PRECIO
	<p>PORTAESCOBILLA CON PORTARROLOS PR/1</p>	<p>9030010001</p>	<p>150,00 €</p>
	<p>PORTAESCOBILLA CON PORTARROLOS PQ/1</p>	<p>9030010002</p>	<p>182,86 €</p>
	<p>PORTAESCOBILLA CON PORTARROLOS PR/2</p>	<p>9031010001</p>	<p>157,14 €</p>
	<p>PORTAESCOBILLA CON PORTARROLOS PQ/2</p>	<p>9031010002</p>	<p>200,00 €</p>

ARTÍCULO	DESCRIPCIÓN	REFERENCIA	PRECIO
	<p>PORTAESCOBILLA CON PORTARROLOS RESERVA/REPUESTO PR/3</p>	<p>9032010001</p>	<p>285,71€</p>
	<p>PORTARROLOS Y RESERVA/REPUESTO 2-PR</p>	<p>9049010001</p>	<p>97,14 €</p>
	<p>PORTARROLOS Y TOALLERO ANILLA Y RESERVA/REPUESTO BR-AR/2R</p>	<p>9057010001</p>	<p>240,00 €</p>
	<p>TOALLERO PIE DOBLE CUADRADO</p>	<p>9033010001</p>	<p>148,57 €</p>

ARTÍCULO	DESCRIPCIÓN	REFERENCIA	PRECIO
	TOALLERO PIE DOBLE REDONDO	9033010002	125,71 €
	PORTAESCOBILLA ESTÁNDAR SUELO	9045000001	72,57 €
	PORTAESCOBILLA ESTÁNDAR PARED	9045000002	76,57 €
	PORTAESCOBILLA ESTÁNDAR SUELO ACERO INOX	9045000003	67,14 €
	PORTAESCOBILLA ESTÁNDAR PARED ACERO INOX	9045000004	70,86 €
	PORTAESCOBILLA CON PORTARROLOS 1-PR ACERO INOX	9044010001	142,86 €

ARTÍCULO	DESCRIPCIÓN	REFERENCIA	PRECIO
	TOALLERO PIE R1 ACERO INOX	9033010004	91,43 €
	TOALLERO PIE R2 ACERO INOX	9033010005	148,57 €
	TOALLERO PIE DOBLE	9059010002	177,14 €
	TOALLERO PIE TRIPLE	9059010003	228,57 €

ARTÍCULO

DESCRIPCIÓN

REFERENCIA

PRECIO



ESPEJO AUMENTO 3X MESA BRD Ø185

9051010001

142,86 €



ESPEJO AUMENTO 3X MESA BQD Ø185

9051010002

148,57 €



ESPEJO MESA RECTANGULAR C/30X25

9051010003

142,86 €



ESPEJO AUMENTO 3X PARED BR

9050010003

120,00 €

ARTÍCULO	DESCRIPCIÓN	REFERENCIA	PRECIO
	ESPEJO AUMENTO 3X PARED Ø200 2 BRAZOS	9050010003	185,71 €
	ESPEJO AUMENTO 3X PARED Ø200 2 BRAZOS ACERO INOX	9050010004	128,57 €

HOTELES - ZONAS PÚBLICAS

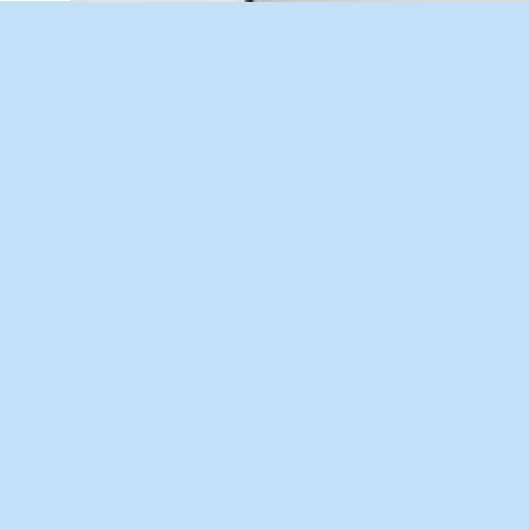

ARTÍCULO

DESCRIPCIÓN

REFERENCIA

PRECIO



DISPENSADOR ESPUMA

9062013000

128,57 €



DISPENSADOR PAPEL HIGIÉNICO

9060013000

148,57 €



DISPENSADOR TOALLAS PEQUEÑO

9064013002

142,86 €

DISPENSADOR TOALLAS MEDIANO

9064013001

157,14 €



DISPENSADOR KLEENEX

9064013004

74,29 €





MARÇAL

HOME DECOR PRODUCTS

www.marcal.pt · marcal@marcal.pt
Tel (+351) 227 419 320 · (+351) 961 346 110
Fax (+351) 227 419 328
Rua da Saibreira, 200
Zona Industrial da Feiteira
4415 - 538 GRIJÓ - V. N. Gaia - Portugal

cofinanciado por:



UNIÃO EUROPEIA

Fundo Europeu
de Desenvolvimento Regional